

# EVA-TECH DECK INSTALLATION GUIDE

**Eva-tech**®



### TABLE OF CONTENTS

1.	Introduction	page 3
2.	Pre-Installation	page 3
3.	Expansion and contraction	page 4-7
4.	Cutting	page 7
5.	Spans and supports	page 8-9
6.	Ventilation	page 9
7.	Fasteners	page 9
8.	Deck installation	page 10
9.	Ripping on an Eva-tech I-Series board	page 11
10.	Top fixing applications	page 12
11.	Cover angles	page 12
12.	Disclaimers and Copyright	page 13

## 1. Introduction

Thank you for choosing Eva-tech decking. In this guideline we aim to assist you in successfully completing an installation that will last as long as your Eva-tech decking products.

Please note the limitations of this guide:

- The person using these guidelines should already have a basic understanding of deck building practices.
- Decks must be built in accordance with local building codes.

Please bear in mind that decks of varying shapes may require different calculations and techniques. Please do not hesitate to contact Eva-Last should you need any technical assistance at any stage of your build.

## 2. Pre-installation

### Standards

Before installing any Eva-Last product, ensure that the application is rational and complies with the local regulations and building codes. Wherever necessary, consult a suitably qualified professional. Where manufacturers and building codes differ, revert to the building code requirements. Check that your choice of product is suitable for its intended application. For further product specification and information visit [www.eva-last.com](http://www.eva-last.com).

### Safety

- Always wear appropriate Personal Protection Equipment (PPE). Comply with the local occupational health and safety legislation.
- Refer to the applicable Material Safety Data Sheet (MSDS).
- Cut boards may have sharp edges (particularly mitered cuts).
- Wear gloves when working with boards.

### Storage & handling

- Individual boards are lighter than WPC and can be more easily handled. Boards are, however, bundled for convenience and can, as a result, be heavy. Take care when lifting, placing or removing from raised pallets. More than one person may be required for lifting depending on the length of the boards and the number of boards within a bundle. Ensure the mass handled does not exceed safe limits as defined by applicable local legislation.
- When handling lengths of boards greater than 4m, ensure both ends are lifted simultaneously and evenly. Lift the boards 1 m from each end to provide better control.
- Handle the boards carefully. Dropping the boards (and all high impact loads in general) can result in damage to the profiles.
- During transportation use corner protectors where strapping is required.
- All components should be stored completely under cover.
- When storing boards, a pallet or flat surface should be used to support the full length of each component.
- All components should be securely stored.
- No component should sit in water or similar.
- Avoid over-stacking and/or eccentric stacking.

### Plan

- Assess the site environment and ensure the product is suitable for the intended application.
- Classify the corrosion category, loading class, and any other property that will influence the selection of product.
- Determine appropriate spans for the selected profile. This will depend on the application and the loading class for the region.
- Suggested spans are provided for typical residential scenarios (refer to Installation guide).
- An appropriately qualified professional must be consulted whenever necessary to ensure the product, this document and the intended application complies with all applicable legislation for that region.
- Develop a maintenance plan to ensure the longevity of the system. This should consider drainage, corrosion and vegetation under and around the deck.

### Site preparation

- Ensure adequate drainage below the deck footprint. Prevent pooling water and/or erosion.
- Remove vegetation from the deck footprint and place an appropriate geotextile to prevent regrowth.

### 3. Expansion and contraction

The extrusion process Eva-Last employs utilizes incredibly high pressures but low rates, resulting in products that are generally more dense than wood. The HDPE component of the material make-up is susceptible to slightly greater expansion and contraction than traditional timber. This is partially mitigated by the intersection of bamboo fibres and mineral particles present throughout a product's profile.

The total change in length will depend on the total change in temperature and the length of the profile. The total change in length of a 5 450 mm profile over a temperature change of 30°C will be (on average) approximately 6.54 mm. Compared to timber, Eva-Last composites experience more expansion and contraction. Timber is typically more susceptible to irregular activity, such as twisting, and larger deformation due to moisture absorption. Eva-Last products have an absorption rate of less than 0.2% and the movement of composite is more uniform. As a result, Eva-Last profiles will remain more true to their form.

The homogeneous movement of composite is easily accounted for during installation. The anticipated change in length can be accommodated for using expansion gaps at either end, or at both ends depending on the intended design and by using the HULK hidden fastener system. To optimize the size of the expansion gaps, the maximum expected temperature range - in relation to the installed ambient temperature - should be calculated and the corresponding change in length calculated.

#### Estimated expansion allowance between 2 fixed points: Example (Refer to the steps of calculation on page 6-7)

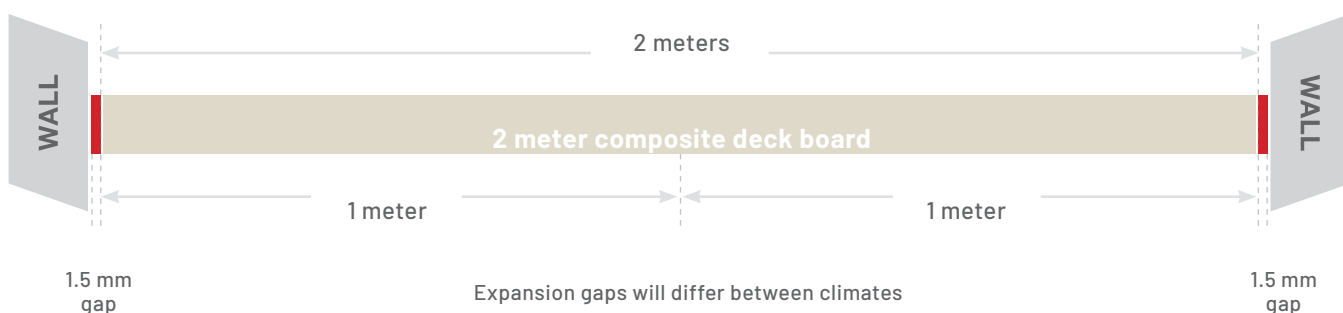

In a warm climate boards expand at a maximum of 1.5 mm/m of composite deck board. Expansion gaps will differ between cool and warm climates. When leaving an expansion gap for each board one should compare the current installation temperature (ambient) to what is a common maximum or minimum temperature for that site. If you are installing at 06:00 in the morning in the middle of winter it will be close to the minimum temperature the board will experience, as a result the board will be the 'shortest' it will ever be at installation. As the temperature rises the board will expand. When its get to the peak temperature in the middle of summer the board will have moved to the 'longest' it will ever be. The difference between the longest and shortest positions of the board dictate the required size of the expansion gap. But the starting position of the expansion gap will depend on the starting temperature or installation temperature. Therefore, boards installed closer to the minimum site temperature will have to have a relatively larger starting expansion gap. Boards installed closer to the maximum site temperature will have to have a relatively smaller starting expansion gap as the boards will 'shrink' as the temperature decreases.

An installation can take place over a few days resulting in varying installation temperatures depending on the project site, the boards may experience differing heating and cooling rates. Therefore will expand and contract at varying rates. Once installation is complete, leave the installed boards to acclimatize before cutting them to the desired length.

Starter or solid boards can be used to create a border around the deck. This will aid in controlling expansion resulting in better aesthetics. Noggins will need to be used to support the border board. The breaker board will need to be top fixed to every noggin.

Breaker boards can be used to control board movement, and give the illusion of straight lines.

**Note:** Hulk Fasteners are used to control expansion and contraction.

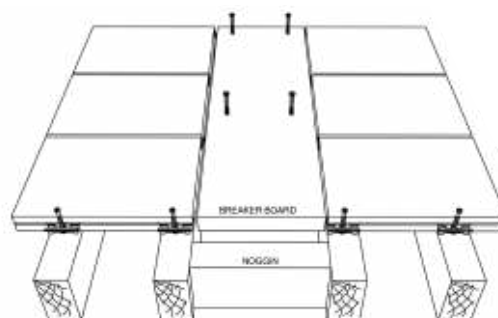

Steps to consider when planning the expansion or contraction gaps of your deck:

### Step 1: Assess the material properties

Material properties	Value	Units
Linear thermal expansion coefficient of Eva-tech	$39.3 \times 10^{-6}$	$\text{mm}^{-1} \text{ } ^\circ\text{C}^{-1}$
Resultant expansion or contraction per meter of board per degree of temperature change	0.04	$\text{m}^{-1} \text{ } ^\circ\text{C}^{-1}$

### Step 2: Assess the climatic properties

Please note these climate properties are a guideline. It is highly recommended that you refer to your local climate data for climate properties specific to your region before commencing your installation

Climatic properties	Climate types		Units
	Coastal	Continental	
Typical seasonal temperature change (conservative and simplified) for different climates	15	30	$^\circ\text{C}$
Seasonal expansion and contraction per meter for different climates	0.6	1.2	$\text{m}^{-1}$

### Step 3: Estimate maximum total seasonal change in length (mm) of board lengths

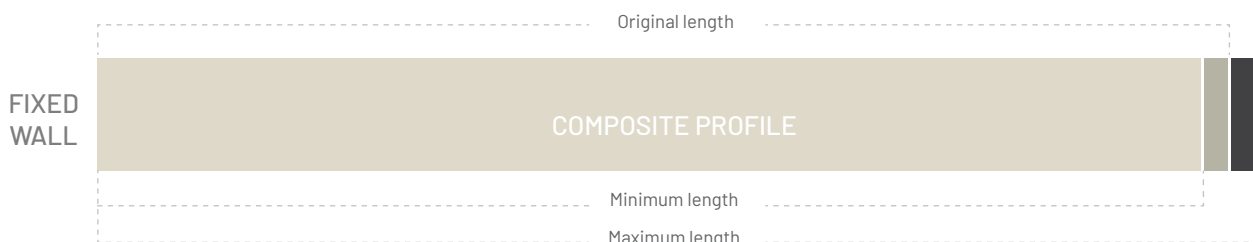

### Step 4: Distribute the maximum seasonal change in length (mm) over both ends of the boards

Movement of composite is typically uniform throughout the board and expansion gaps must attempt to cater for this. Providing expansion gaps at both ends of the boards is good practice. The total expansion gap length (as per the above climate and board lengths) for each side of the board when employing this approach is half the maximum calculated previously.



### Expansion gap design is application dependent:

Typical installations will have border boards or perimeter boards between or at the end of each longitudinally-placed board. The expansion gap in these cases will be as has been calculated above, depending on the climate and original length of board.

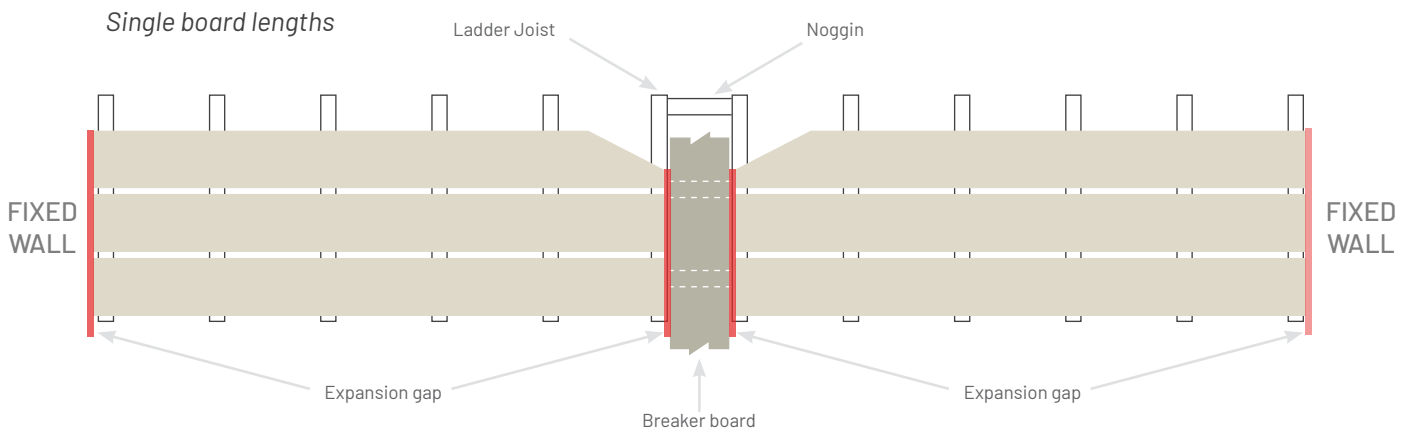

### Multiple board lengths placed consecutively

Expansion gap provided for the change in length of both boards.

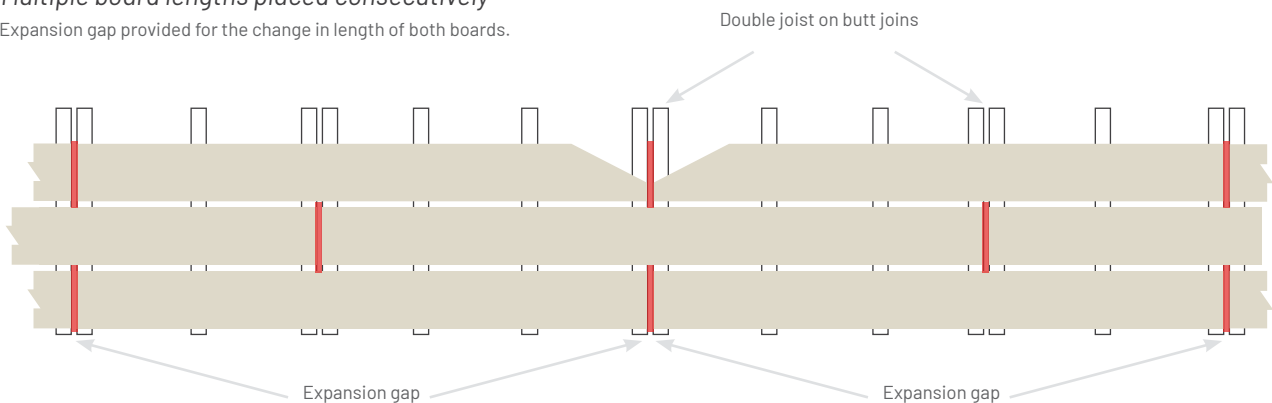

### Code compliance:

When installing against vertical structures, allow for both the code required spacing and the required expansion gap to ensure transgression of the code does not occur as a result of board movement.

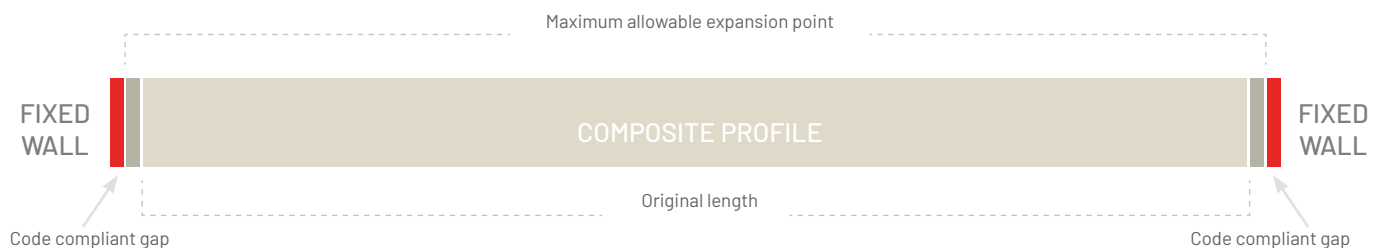

### Expansion gap installation is project site dependent:

If the ambient temperature of the site at the time of installation is the expected average temperature of the site then the expansion gap at installation must be the average of the expected minimum and maximum lengths of the boards.

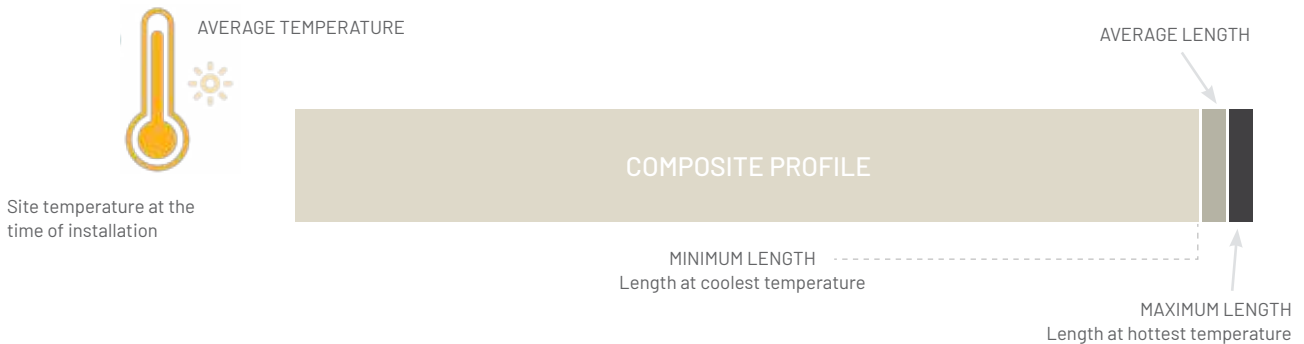

If the site is hotter than the expected average temperature, then the boards are expected to contract when the temperature drops to the average and the installed gap must be adjusted narrower accordingly.

If the site is colder than the expected average temperature, then the boards are expected to expand when the temperature increases to the average and the installed gap must be adjusted wider accordingly.

**Note:** All measurements are provided to the nearest decimal place where possible for simplicity. All measurements are based on simplified temperature ranges for typical climates and must be adjusted accordingly for different temperatures ranges or different climates. All measurements are based on multiples of the typical board length of 5.45 m and must be adjusted accordingly for boards of different lengths.

## 4. Cutting

- Use a fine toothed, carbide tipped blade to cut composite material.
- Use an 80-tooth, 260 mm diameter cross-cut, or finer, blade.
- Ripping boards to 60 mm is applicable when using a top fixer and a clip, but 90 mm when only using top fixers. This will allow for 2 fasteners per joist with a min of 30 mm from any fastener or edge.
- Boards can be mitered. Use three fasteners, evenly spaced and 30 mm from any edge, per mitered board.

Consider the following when cutting with a circular saw, compound mitre saw, etc.

- Ensure that the board is properly supported and horizontal before cutting.
- Properly support the board to avoid pinching the blade or cracking the board.
- Take measurements only when the board is flat to avoid inaccuracies.
- Use a pencil or chalk to mark boards.
- **Tip** – The sharpness of a blade will affect the quality of the cut.

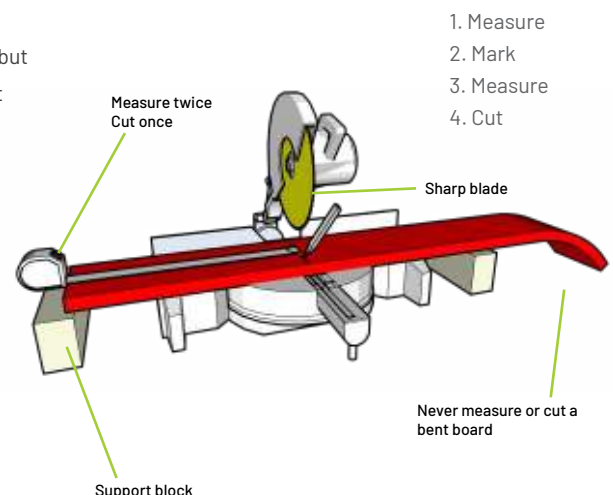

### 5. Supports and spans

The choice of structural material will effect the life span of a deck. Make certain that local building codes are followed. When installing a deck board, ensure that board ends are supported and securely fastened. Boards should not be allowed to overhang more than 30 mm.

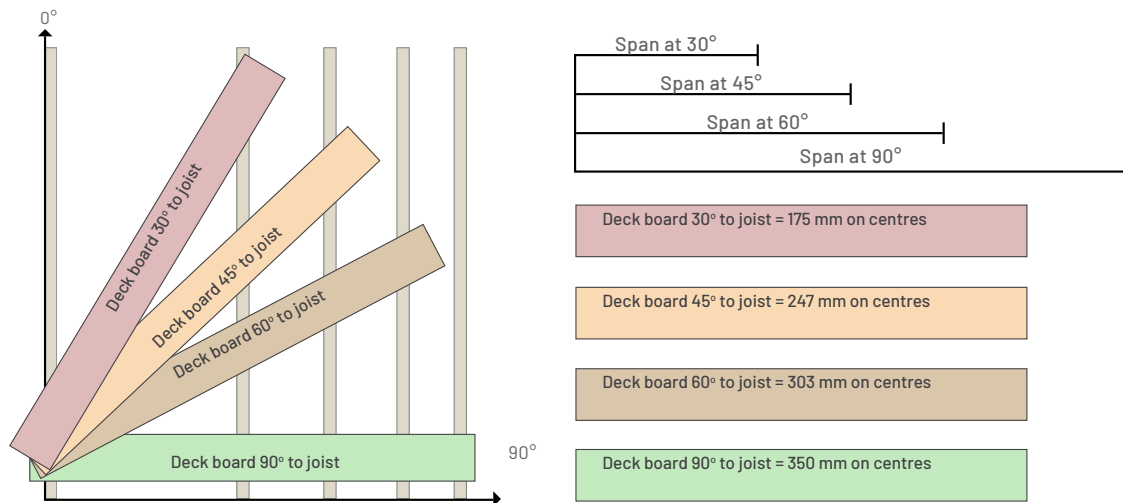

Joist spacing to consider when deck boards at different angles to joists:

Common spans at 90° to a support joist (normal)	Common laying pattern angles		
	60°	45°	30°
300 mm	260 mm	212 mm	150 mm
350 mm	303 mm	247 mm	175 mm

Additional supports are necessary for:

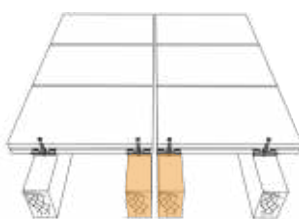

1. Double joists → Butt joints

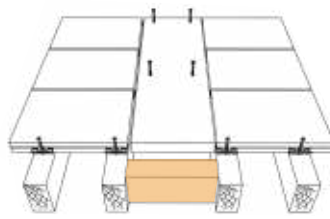

2. Noggins → Breaker boards

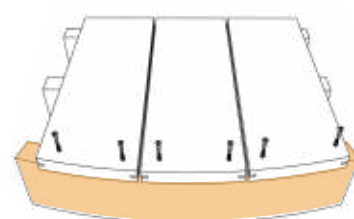

3. Ring beams → All deck edges

#### Foamed PVC composite Joist installation guide

- Composite battens come in lengths of up to 2.9 m and make for excellent moisture-resistant decking joists.
- These battens are not structural members and should not be allowed to span any distance.
- The surface that the battens are to be installed upon need to satisfy applicable standards for that region. Typical characteristics to consider include checking that the surface is smooth and has a consistent gradient to ensure water drains away from the deck. Note that one should not install battens across this gradient but rather with the gradient to prevent water pooling against the battens. The surface should also be able to satisfy the loading requirements anticipated for the deck. On slightly undulating surfaces, spacers can be utilised to ensure the deck is level. Where battens impede drainage or in scenarios where pooling water may occur, spacers can also be used to raise the battens off of the installation surface. Care must be taken in these circumstances, ensuring that the design and installation still satisfies local standards and the material properties of the products. Use 3 mm to 5 mm (rubber or similar) spacers. The location of these spacers will be application dependent but typically can be installed at 300 mm intervals (c/c) for residential applications. For commercial applications, confirm the appropriate interval with the project engineer.
- The composite batten is a 30 x 40 mm rectangular profile, providing two different heights at which the deck boards can be installed; 30 mm or 40 mm. These heights also make this product suitable for applications where the available height between the current surface and the intended top of deck level is limited.
- Composite battens should be laid parallel to one another at distances appropriate for the span of the intended deck profile and the



application. The decking boards are then installed atop the battens perpendicular to the batten laying pattern, in the same installation manner as when traditional decking joists are employed.

- Battens should be pre-drilled and secured to the installation surface with an appropriate anchor, or similar, in a manner that satisfies applicable local standards. Fasteners with appropriate structural and corrosion resistance for the application should be utilised. Seven fastening points per 2.9 m batten length is typically appropriate but this is application dependent and should be verified.
- Allow for expansion gaps between battens installed longitudinally. Expansion gaps should be positioned strategically so as not to negatively impact the installation of deck boards atop the battens. Utilise an expansion coefficient of  $45 \times 10^{-6}$  mm/mm/degree Celsius when estimating an appropriate expansion gap.
- When fastening a deck board to a batten, or similar, ensure the selected fastener is not longer than the combined thickness of the batten and board.
- Eva-Last produces both foamed PVC and cellulose-polymer composite battens. Please note that the cellulose-polymer composite battens are not suitable for joist type applications.
- Where necessary, please consult with a professional to ensure your deck is appropriately designed and installed.

### IMPORTANT:

- This system is not intended for use in applications where waterproofing is required.
- The system is generally appropriate for use on screeds, tiled or concrete floors, and similar surfaces that satisfy the above points.

## 6. Ventilation diagram

To avoid rotting, corrosion, and structural damage it is essential that the deck is well ventilated. In addition, expansion gaps, fascia board gaps and sufficient ground clearance are vital, allowing the deck to breathe which modulates temperature fluctuations and helps preserve your deck for years to come.

- Install a 12 mm gap between the deck structure and the wall for drainage.
- Leave a minimum ground clearance of 300 mm.
- Ground clearance over concrete of 30 mm.
- Install a drainage gap at the bottom of your deck and do not block off with fascia boards.

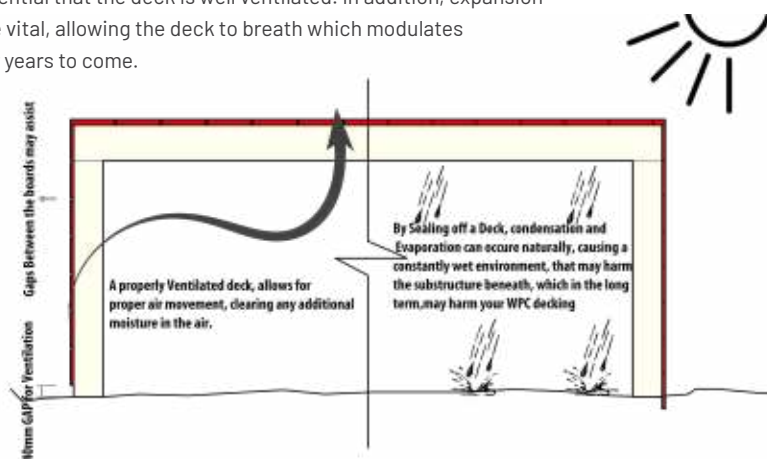

## 7. Fasteners

Eva-Last has developed a range of fasteners that are specially designed to securely fasten the deck boards to a substructure. The coating employed for our HULK fasteners ensure the fixing system supports your deck through out its lifespan.

### HULK FASTENERS.

#### Typical deck fastener used in timber frame application

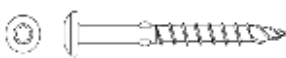
Fastener type	Standard size	Length (mm)	Material	Pull out resistance (N)*	Recommended torque (N/mm)	Note
 Top fixing trim screw	M5.5	48	10B21	4 550 to 7 150	7 450	Designed for boards of 11 to 16 mm thicknesses into timber structures greater than 40 mm thick.
			SS 316	5 000 to 6 500	N/A	

Appropriate fasteners must be employed depending on the expected worst-case loading conditions, the intended application and the conditions present. Particular attention should be paid to the substrate conditions available and the environmental conditions of the site. All applications should adhere to applicable regional standards. All timber profiles should be treated appropriately. Regular and proactive maintenance should be employed.

\*Pull out resistance range is based on testing with fasteners in ACQ timber (density of 0.67 g/cm<sup>3</sup>) to Red oak timber (density of 0.72 g/cm<sup>3</sup>).

### 8. Deck installation

Installation using a grooved deck board: When you install your first board, it is necessary to fasten the first board firmly to the structure, before using hidden fasteners. Be careful not to overdrive the screw.

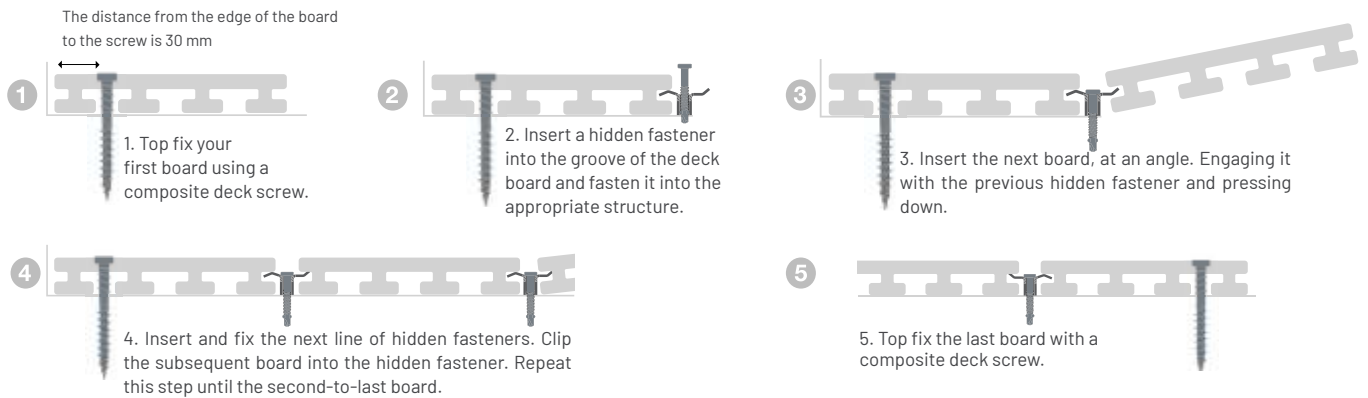

#### SIDE VIEW

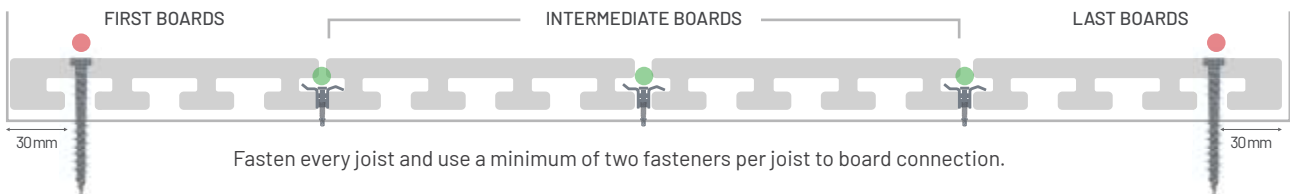

**Note:** Pre-drilling may be required when top fixing.

The I-Series range of profiles has some unusual characteristics which should be taken into account. When top-fixing and ripping down the length, I-Series profiles are superior to other decking profiles when these guidelines are followed. In all other ways, they are used in exactly the same manner as regular decking boards.

### 9. Ripping on an Eva-tech I-Series board

For ease of installation and aesthetics it is recommended that you design your deck so that your board usage is a perfect multiple of the I-Series board profile dimensions. Always remember, when planning your deck design, that you have properly accounted for expansion gaps\*. In instances where your deck measurements will not allow for the exact board width with expansion gaps, it may be necessary to rip the end board (cut the board lengthways) to fit.

While boards can be ripped, it is important to limit the narrowness of the rip. It is advised to avoid cutting a board to less than half its original width. For the I-Series profile we do not recommend ripping the board narrower than 61 mm. It is highly recommended that all ripped, cantilever edges are positioned against a stable structure ie. a wall to prevent any accidental loading and subsequent bowing or breaking of the board. If the remaining space available is less than the minimum rip tolerance, it is good practice is to rip both the first and last boards to account for a wider space for the last board and a thicker rip on both boards.

Ripping a board requires adequate planning. If the site does not allow the flexibility to rip two boards on either edge and the final board must be ripped narrower, the narrowest an I-series board can be ripped is 61 mm, when using a clip and top fixing screw and, 99 mm when top fixing only. The board will still need to be fixed on either side of the profile to ensure it is adequately fastened to the substructure for stability. A single, longitudinal line of fasteners is susceptible to pivoting and may become a hazard.

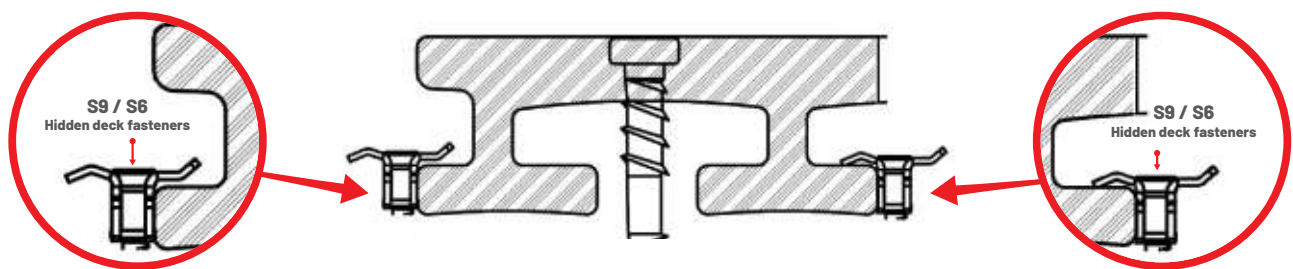

The I-Series board can be ripped but is limited to specific widths that allow the cuts to line up with the outer edge of the second or third foot to mimic the ends of the profile.

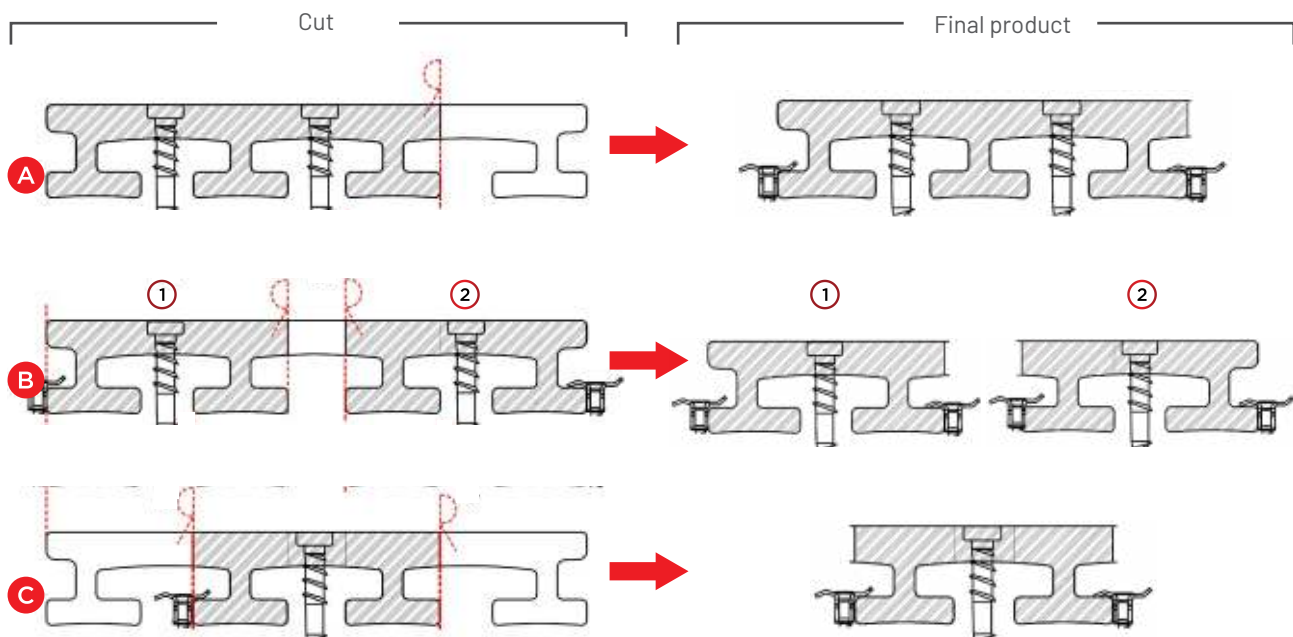

If the longitudinal profile of the ripped board is to be visible, it is good practice to install the board so that the cut face is turned inwards and the opposite face is exposed. However, in scenarios such as this, one should be able to extend the project area so that the final board can be a full board.

### 10. Top fixing applications

Trim and finishing are those specific profiles on a decking application, that must utilise a top fixing fastening detail, mainly due to their position on the layout of the deck.

These scenarios include:

1. The perimeter planks on the outside edges of a deck, which refers to the starting and finishing profile on any section of a deck (whether a full width profile is used or a slimmer ripped profile is required, the same applies) or a full picture frame finish
2. The breaker board planks, which are used to break the deck into sections where expansion and contraction and gap sizes are limited, as well as reduce the wastage factor and create an aesthetic design.

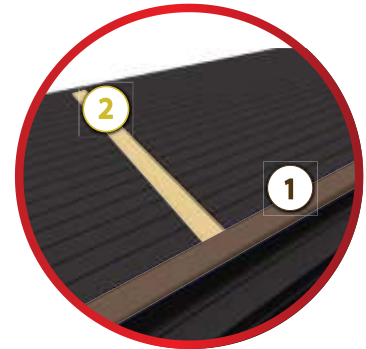

Going forward, in both of the above scenarios we recommend and promote best deck building practices, based on internationally recognised standards.

A starter or square edge profile, must replace the standard I-Series grooved profile for all top fixing requirements on I-Series decks. The total running metres to cover the top fixing requirements on a decking application, should be known and calculated separately for every project going forward, and the correct amount of starter or square edge profiles must be supplied in replacement for those specific sections. This is usually no more than 5 - 10% of the total deck boards required for any deck design. When a board is only top fixed, it requires two top fixers on every joist.

### 11. Cover angles

Accessories include a cover angle with beveled edges and a powder coating that matches the I-Series deck board colour. The lack of sharp edges and slip resistant design makes these cover angles safer for children and pets. When installing cover angle trim, fix the cover angle to the composite profiles. Cover angles running at angles parallel to the board should be fixed every 300 mm and at 30 mm from the outer edge of the I-Series profile to avoid driving the screws into the solid part of the profile.

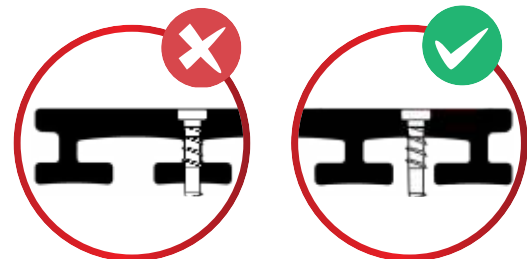

Avoid driving the top fixing screws through the web of the profile shape, this would cause cracking.

## 12. Disclaimer & copyright

### Disclaimer

The provided information is offered in good faith as accurate but without guarantee. Eva-Last makes no warranties or representations of any kind (express or implied) about the accuracy, adequacy, currency, or completeness of the information, or that it is necessarily suitable for the intended use.

Compliance with this document does not guarantee immunity from breach of any statutory requirements, building codes or relevant standards. The final responsibility for the correct design and specification rests with the designer and, for its satisfactory execution, with the contractor. Appropriate warnings and safe handling procedures should be provided to handlers and users.

While most data have been compiled from research, case histories, experience and testing, small changes in the environment can produce marked differences in performance. The decision to use a material, and in what manner, is made at your own risk. The use of a material and method may therefore need to be modified to its intended end use and environment.

Eva-Last, its directors, officers or employees shall not be responsible for any direct, indirect, or special loss or damage arising from, or as a consequence of, use of, or reliance upon, any information contained in this document or other documents referenced herein. Eva-Last expressly disclaims any liability which is based on or arises out of, the information or any errors, omissions, or misstatements herein.

### Drawing disclaimer

All dimensions and specifications are offered in good faith as accurate but without guarantee. The information captured herein may not contain complete details. Eva-Last makes no warranties or representations of any kind (express or implied) about the accuracy, adequacy, currency, or completeness of the information, or that it is necessarily suitable for the intended use.

Compliance with this document does not guarantee immunity from breach of any statutory requirements, building codes or relevant standards. The final responsibility for the correct design and specification rests with the designer and, for its satisfactory execution, with the contractor.

### Utilisation disclaimer

Legislation may differ between jurisdictions. Before installing any Eva-Last product, ensure that the application is rational and complies with the local regulations and building codes. Wherever necessary, consult a suitably qualified professional. Be sure to comply with material manufacturer specifications. Where manufacturers and building codes differ, revert to the building code requirements. Check that your choice of product is suitable for its intended application. For further product specification and information visit [www.eva-last.com](http://www.eva-last.com).

### Copyright

If reprinted or reproduced or utilised in any form Eva-last should be acknowledged as the source of the information. Eva-last periodically updates the information contained in this installation guide and that of the Eva-last documents that have been referenced herein. Before using this installation guide, please refer to the Eva-last website ([www.eva-last.com](http://www.eva-last.com)) for the most recent updates on information contained in this installation guide and that of any referenced Eva-last documents. Please refer to the applicable websites for the most recent updates on information contained herein pertaining to other sources.

### Contact information

Eva-Last  
Room 1203, 12/F Tower 333 Canton Road,  
Tsimshatsui, Hong Kong, China

Emergency Contact: +27 10 593 9220  
Product information: +27 10 593 9220  
Email: [info@eva-last.com](mailto:info@eva-last.com)  
Website: [www.eva-last.com](http://www.eva-last.com)